

CTS2098LN3-HF (NPN)

RoHS Device
Halogen Free

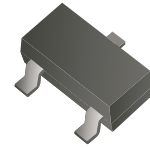

Features

- Low $V_{CE(sat)}$.
- Excellent DC current gain characteristics.

Mechanical data

- Case: SOT-23, molded plastic.
- Mounting position: Any.

Circuit Diagram

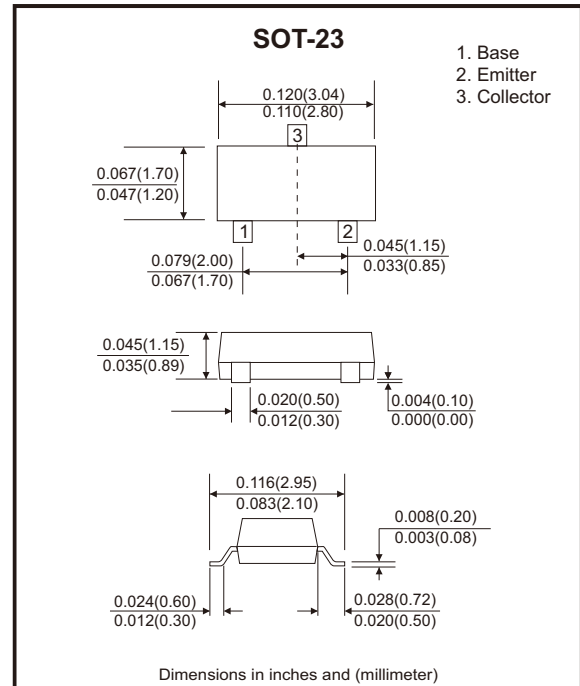
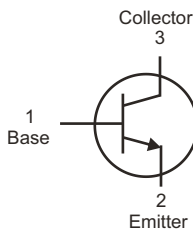

Maximum Ratings (at $T_A=25^{\circ}\text{C}$ unless otherwise noted)

Parameter	Symbol	Value	Units
Collector-Base voltage	V_{CBO}	25	V
Collector-Emitter voltage	V_{CEO}	15	V
Emitter-Base voltage	V_{EBO}	6	V
Collector current (DC)	I_C	5	A
Collector current (Pulse, Note 1)	I_{CP}	8	A
Power dissipation (Note 2)	P_D	0.9	W
Junction temperature	T_J	150	$^{\circ}\text{C}$
Storage temperature range	T_{STG}	-55 to +150	$^{\circ}\text{C}$

Notes:

1. Single pulse $P_w \leq 350\mu\text{s}$, duty $\leq 2\%$.
2. When mounted on a ceramic board with area of $600\text{mm}^2 \times 0.8\text{mm}$.

Electrical Characteristics (at TA=25°C unless otherwise noted)

Parameter	Symbol	Conditions	Min.	Typ.	Max.	Units
Collector-Base breakdown voltage	$V_{(BR)CBO}$	$I_C=50\mu A, I_B=0$	25	-	-	V
Collector-Emitter breakdown voltage	$V_{(BR)CEO}$	$I_C=1mA, I_B=0$	15	-	-	V
Emitter-Base breakdown voltage	$V_{(BR)EBO}$	$I_E=50\mu A, I_C=0$	6	-	-	V
Collector cut-off current	I_{CBO}	$V_{CB}=20V, I_E=0$	-	-	0.1	μA
Emitter cut-off current	I_{EBO}	$V_{EB}=5V, I_C=0$	-	-	0.1	μA
DC current gain (Note 1)	$h_{FE(1)}$	$V_{CE}=2V, I_C=500mA$	270	-	820	
	$h_{FE(2)}$	$V_{CE}=2V, I_C=2A$	160	-	-	
Collector-Emitter saturation voltage (Note 1)	$V_{CE(sat)}$	$I_C=3A, I_B=0.1A$	-	0.25	0.5	V
Output capacitance	C_{ob}	$V_{CB}=20V, I_E=0A, f=1MHz$	-	-	50	pF
Transition frequency	f_T	$V_{CE}=6V, I_C=50mA, f=200MHz$	-	150	-	MHz

Notes: 1. Pulse test: Pulse Width $\leq 380\mu s$, Duty Cycle $\leq 2\%$.

Rating and Characteristic Curves (CTS2098LN3-HF)

Fig.1 - Current Gain vs. Collector Current

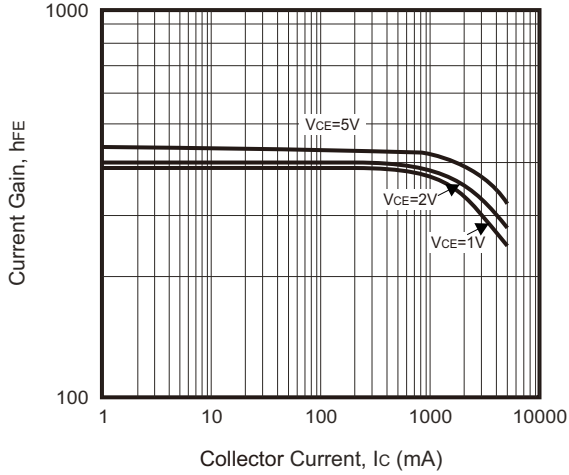

Fig.2 - Saturation Voltage vs. Collector Current

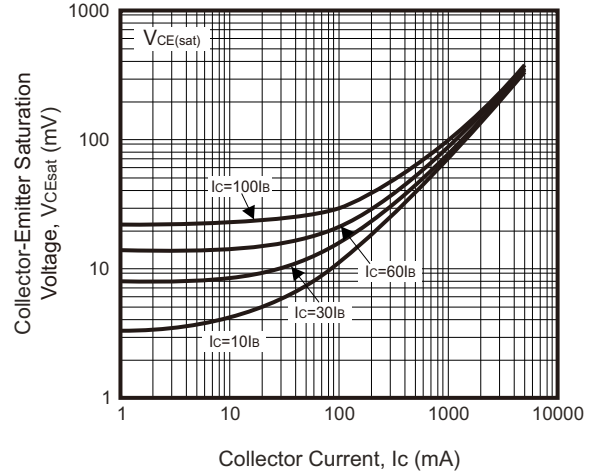

Fig.3 - Saturation Voltage vs. Collector Current

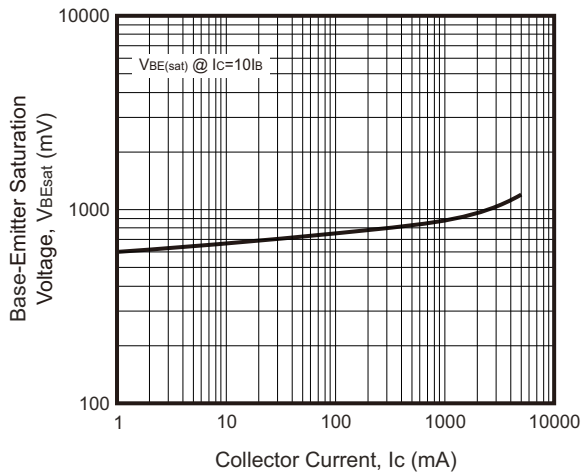
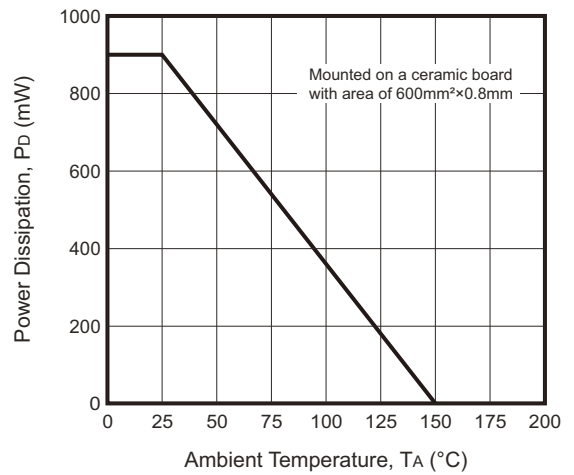
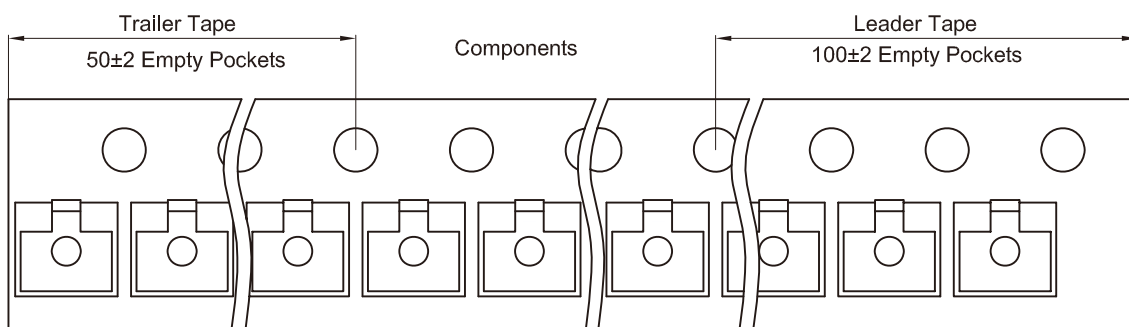
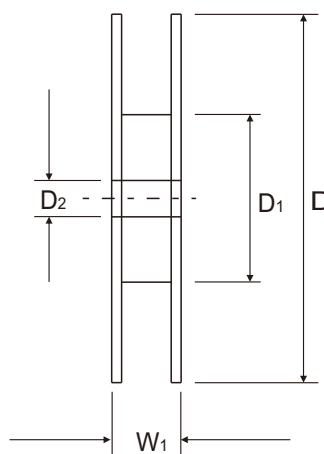
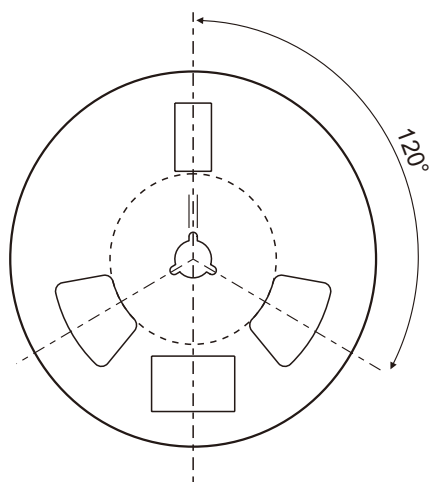
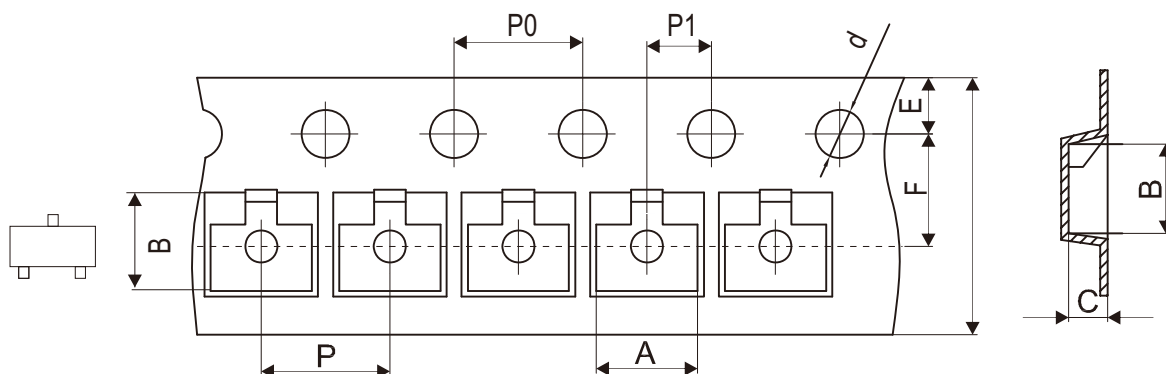

Fig.4 - Power Derating Curve



Reel Taping Specification



SOT-23	SYMBOL	A	B	C	d	D	D1	D2
	(mm)	3.17 ± 0.10	3.23 ± 0.10	1.37 ± 0.10	1.50 + 0.10	178.00 ± 1.00	55.00 ± 1.00	13.00 ± 0.50
	(inch)	0.125 ± 0.004	0.127 ± 0.004	0.054 ± 0.004	0.059 + 0.004	7.008 ± 0.039	2.165 ± 0.039	0.512 ± 0.020

SOT-23	SYMBOL	E	F	P	P0	P1	W	W1
	(mm)	1.75 ± 0.10	3.50 ± 0.05	4.00 ± 0.10	4.00 ± 0.10	2.00 ± 0.05	8.00 + 0.30 / - 0.10	12.00 ± 0.50
	(inch)	0.069 ± 0.004	0.138 ± 0.002	0.157 ± 0.004	0.157 ± 0.004	0.079 ± 0.002	0.315 + 0.012 / - 0.004	0.472 ± 0.020

Marking Code

Part Number	Marking Code
CTS2098LN3-HF	AH

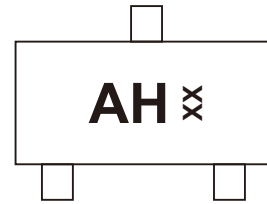

XX = Control code

Suggested P.C.B. PAD Layout

SIZE	SOT-23	
	(mm)	(inch)
A	0.90	0.035
B	0.80	0.031
C	0.95	0.037
D	2.00	0.079

Note: The pad layout is for reference purposes only.

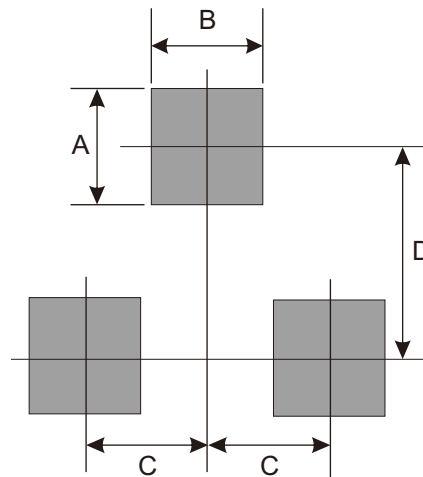

Standard Packaging

Case Type	REEL PACK	
	REEL (pcs)	Reel Size (inch)
SOT-23	3,000	7